

IRG4RC10UD

INSULATED GATE BIPOLAR TRANSISTOR WITH ULTRAFast SOFT RECOVERY DIODE UltraFast CoPack IGBT

Features

- UltraFast: Optimized for medium operating frequencies (8-40 kHz in hard switching, >200 kHz in resonant mode).
- Generation 4 IGBT design provides tighter parameter distribution and higher efficiency than previous generation
- IGBT co-packaged with HEXFRED™ ultrafast, ultra-soft-recovery anti-parallel diodes for use in bridge configurations
- Industry standard TO-252AA package

Benefits

- Generation 4 IGBT's offer highest efficiencies available
- IGBT's optimized for specific application conditions
- HEXFRED diodes optimized for performance with IGBT's . Minimized recovery characteristics require less/no snubbing
- Lower losses than MOSFET's conduction and Diode losses

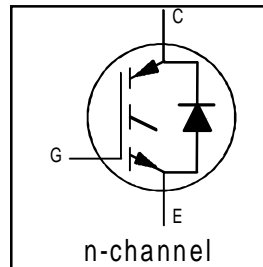

$V_{CES} = 600V$
$V_{CE(on) typ.} = 2.15V$
@ $V_{GE} = 15V, I_C = 5.0A$
$t_f (typ.) = 140ns$

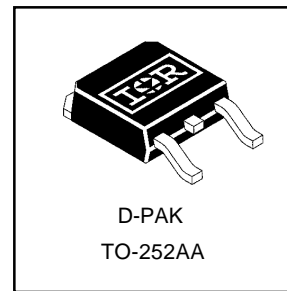

Absolute Maximum Ratings

	Parameter	Max.	Units
V_{CES}	Collector-to-Emitter Voltage	600	V
$I_C @ T_C = 25^\circ C$	Continuous Collector Current	8.5	A
$I_C @ T_C = 100^\circ C$	Continuous Collector Current	5.0	
I_{CM}	Pulsed Collector Current ①	34	
I_{LM}	Clamped Inductive Load Current ②	34	
$I_F @ T_C = 100^\circ C$	Diode Continuous Forward Current	4.0	
I_{FM}	Diode Maximum Forward Current	16	
V_{GE}	Gate-to-Emitter Voltage	± 20	V
$P_D @ T_C = 25^\circ C$	Maximum Power Dissipation	38	W
$P_D @ T_C = 100^\circ C$	Maximum Power Dissipation	15	
T_J	Operating Junction and	-55 to +150	°C
T_{STG}	Storage Temperature Range		
	Soldering Temperature, for 10 sec.	300 (0.063 in. (1.6mm) from case)	
	Mounting Torque, 6-32 or M3 Screw.	10 lbf•in (1.1 N•m)	

Thermal Resistance

	Parameter	Min.	Typ.	Max.	Units
$R_{\theta JC}$	Junction-to-Case - IGBT	—	—	3.3	°C/W
$R_{\theta JC}$	Junction-to-Case - Diode	—	—	7.0	
$R_{\theta JA}$	Junction-to-Ambient (PCB mount)*	—	—	50	
Wt	Weight	—	0.3 (0.01)	—	g (oz)

Details of note ① through ④ are on the last page

IRG4RC10UD

Electrical Characteristics @ T_J = 25°C (unless otherwise specified)

	Parameter	Min.	Typ.	Max.	Units	Conditions	
V _{(BR)CES}	Collector-to-Emitter Breakdown Voltage ^③	600	—	—	V	V _{GE} = 0V, I _C = 250μA	
ΔV _{(BR)CES} /ΔT _J	Temperature Coeff. of Breakdown Voltage	—	0.54	—	V/°C	V _{GE} = 0V, I _C = 1.0mA	
V _{CE(on)}	Collector-to-Emitter Saturation Voltage	—	2.15	2.6	V	V _{GE} = 15V See Fig. 2, 5	
		—	2.61	—			I _C = 5.0A
		—	2.30	—			I _C = 8.5A
V _{GE(th)}	Gate Threshold Voltage	3.0	—	6.0		V _{CE} = V _{GE} , I _C = 250μA	
ΔV _{GE(th)} /ΔT _J	Temperature Coeff. of Threshold Voltage	—	-8.7	—	mV/°C	V _{CE} = V _{GE} , I _C = 250μA	
g _{fe}	Forward Transconductance ^④	2.8	4.2	—	S	V _{CE} = 100V, I _C = 5.0A	
I _{CES}	Zero Gate Voltage Collector Current	—	—	250	μA	V _{GE} = 0V, V _{CE} = 600V	
		—	—	1000		V _{GE} = 0V, V _{CE} = 600V, T _J = 150°C	
V _{FM}	Diode Forward Voltage Drop	—	1.5	1.8	V	I _C = 4.0A See Fig. 13	
		—	1.4	1.7			I _C = 4.0A, T _J = 125°C
I _{GES}	Gate-to-Emitter Leakage Current	—	—	±100	nA	V _{GE} = ±20V	

Switching Characteristics @ T_J = 25°C (unless otherwise specified)

	Parameter	Min.	Typ.	Max.	Units	Conditions
Q _g	Total Gate Charge (turn-on)	—	15	22	nC	I _C = 5.0A V _{CC} = 400V V _{GE} = 15V See Fig. 8
Q _{ge}	Gate - Emitter Charge (turn-on)	—	2.6	4.0		
Q _{gc}	Gate - Collector Charge (turn-on)	—	5.8	8.7		
t _{d(on)}	Turn-On Delay Time	—	40	—	ns	T _J = 25°C I _C = 5.0A, V _{CC} = 480V V _{GE} = 15V, R _G = 100Ω Energy losses include "tail" and diode reverse recovery. See Fig. 9, 10, 18
t _r	Rise Time	—	16	—		
t _{d(off)}	Turn-Off Delay Time	—	87	130		
t _f	Fall Time	—	140	210		
E _{on}	Turn-On Switching Loss	—	0.14	—	mJ	T _J = 150°C, See Fig. 11, 18 I _C = 5.0A, V _{CC} = 480V V _{GE} = 15V, R _G = 100Ω Energy losses include "tail" and diode reverse recovery.
E _{off}	Turn-Off Switching Loss	—	0.12	—		
E _{ts}	Total Switching Loss	—	0.26	0.33		
t _{d(on)}	Turn-On Delay Time	—	38	—	ns	Measured 5mm from package
t _r	Rise Time	—	18	—		
t _{d(off)}	Turn-Off Delay Time	—	95	—		
t _f	Fall Time	—	250	—		
E _{ts}	Total Switching Loss	—	0.45	—	mJ	
L _E	Internal Emitter Inductance	—	7.5	—	nH	
C _{ies}	Input Capacitance	—	270	—	pF	V _{GE} = 0V V _{CC} = 30V f = 1.0MHz See Fig. 7
C _{oes}	Output Capacitance	—	21	—		
C _{res}	Reverse Transfer Capacitance	—	3.5	—		
t _{rr}	Diode Reverse Recovery Time	—	28	42	ns	T _J = 25°C See Fig. 14 T _J = 125°C
		—	38	57		
I _{rr}	Diode Peak Reverse Recovery Current	—	2.9	5.2	A	T _J = 25°C See Fig. 15 T _J = 125°C
		—	3.7	6.7		
Q _{rr}	Diode Reverse Recovery Charge	—	40	60	nC	T _J = 25°C See Fig. 16 T _J = 125°C
		—	70	105		
di _(rec) M/dt	Diode Peak Rate of Fall of Recovery During t _b	—	280	—	A/μs	T _J = 25°C See Fig. 17 T _J = 125°C
		—	235	—		

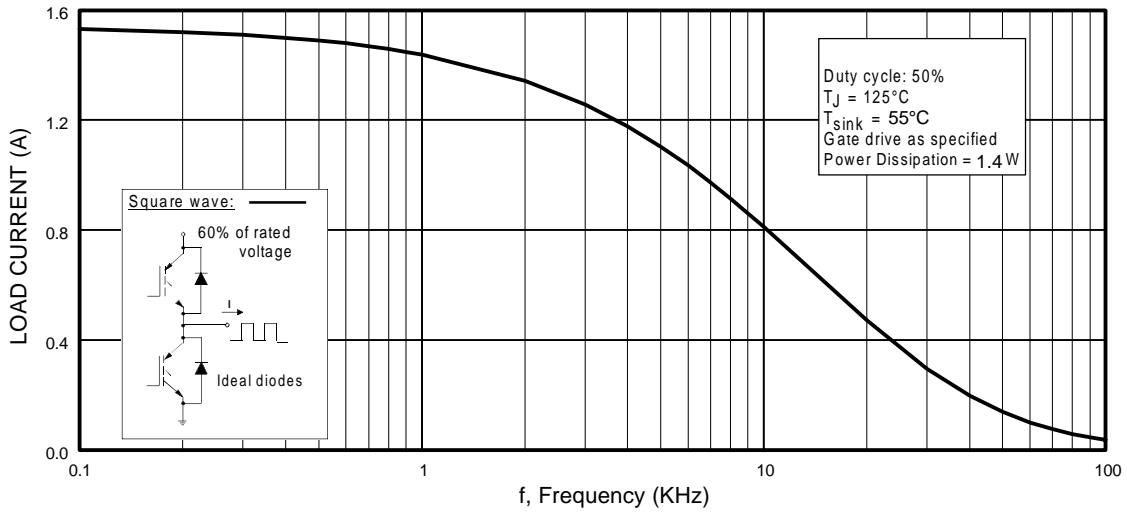

Fig. 1 - Typical Load Current vs. Frequency
 (Load Current = I_{RMS} of fundamental)

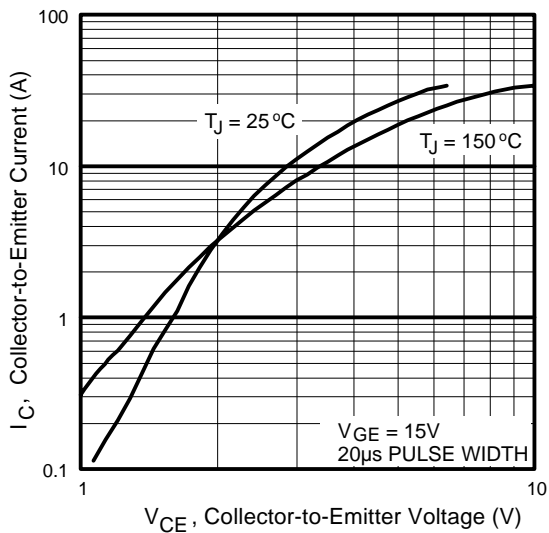

Fig. 2 - Typical Output Characteristics

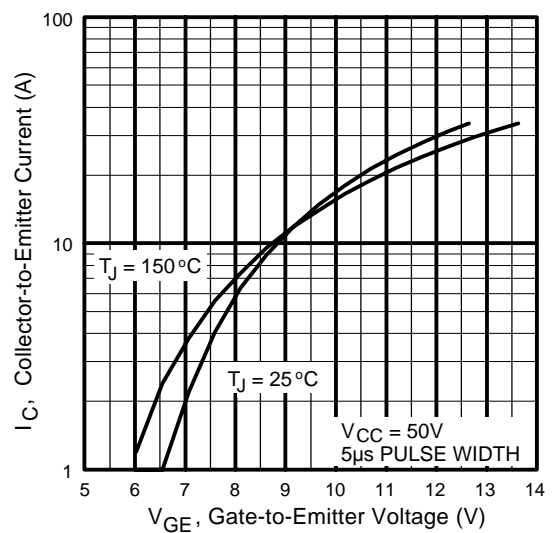

Fig. 3 - Typical Transfer Characteristics

IRG4RC10UD

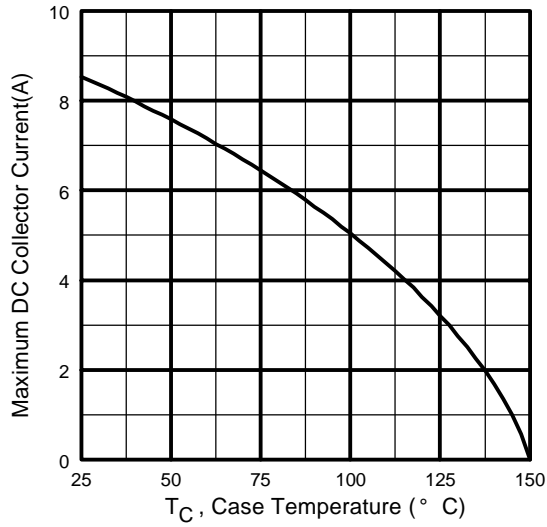

Fig. 4 - Maximum Collector Current vs. Case Temperature

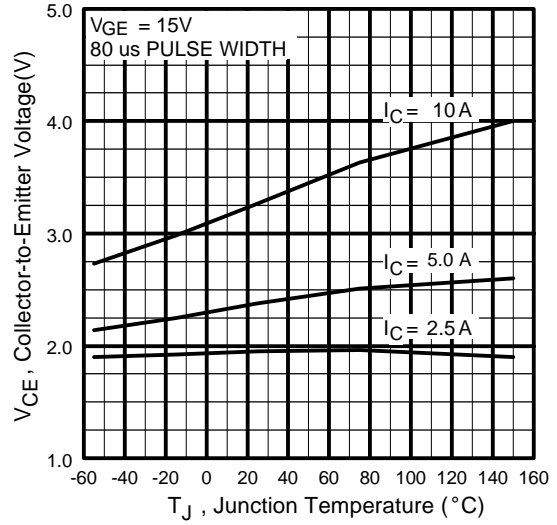

Fig. 5 - Typical Collector-to-Emitter Voltage vs. Junction Temperature

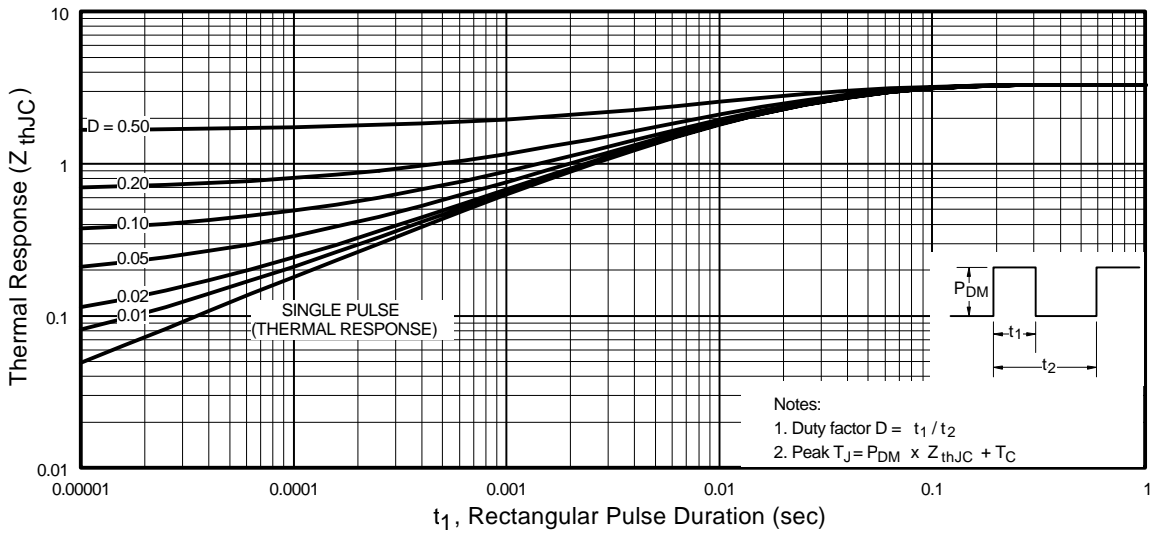

Fig. 6 - Maximum Effective Transient Thermal Impedance, Junction-to-Case

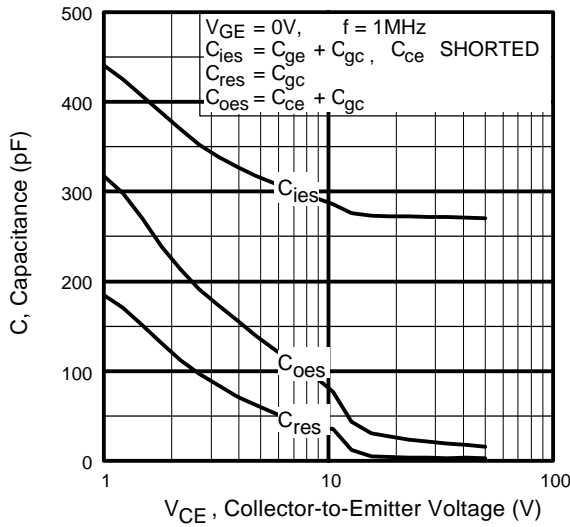

Fig. 7 - Typical Capacitance vs. Collector-to-Emitter Voltage

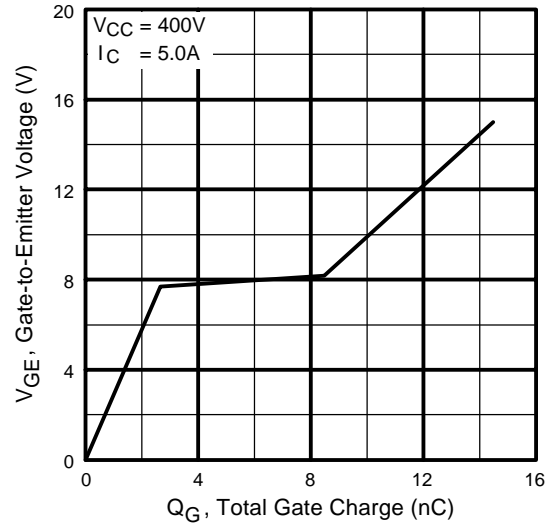

Fig. 8 - Typical Gate Charge vs. Gate-to-Emitter Voltage

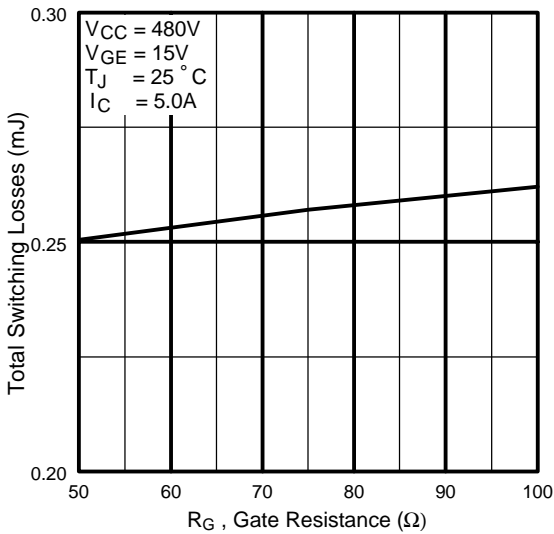

Fig. 9 - Typical Switching Losses vs. Gate Resistance

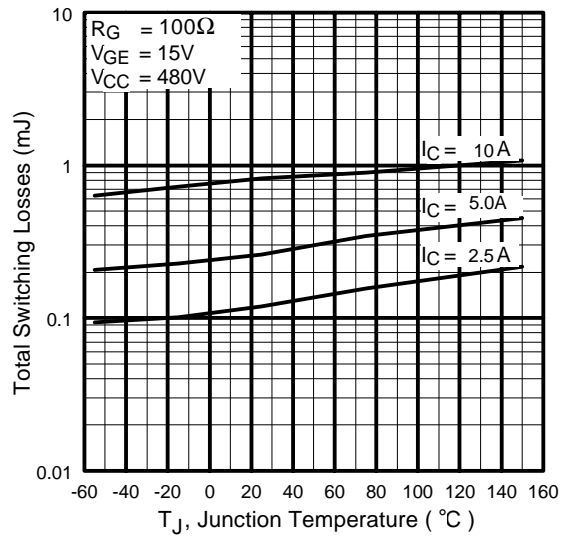

Fig. 10 - Typical Switching Losses vs. Junction Temperature

IRG4RC10UD

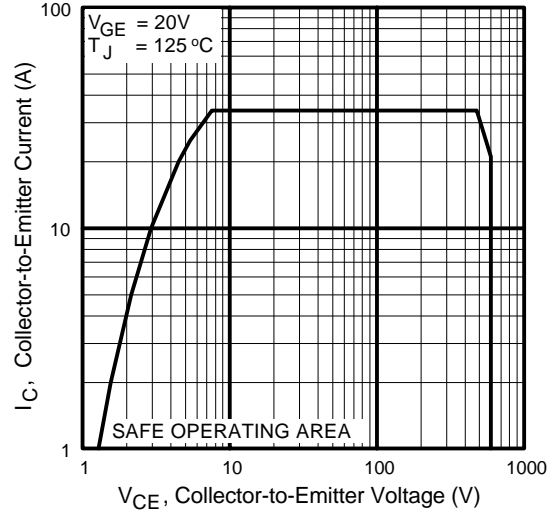
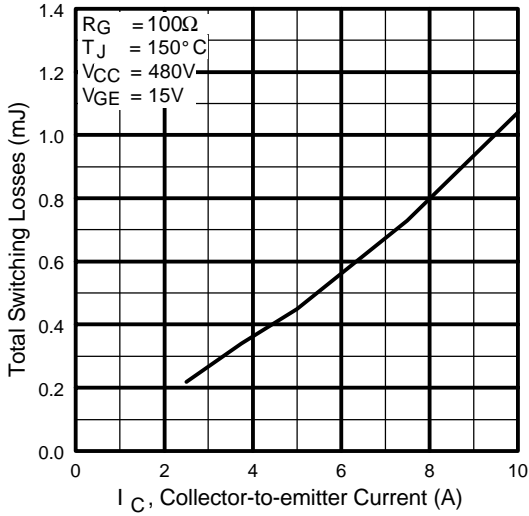

Fig. 11 - Typical Switching Losses vs. Collector-to-Emitter Current

Fig. 12 - Turn-Off SOA

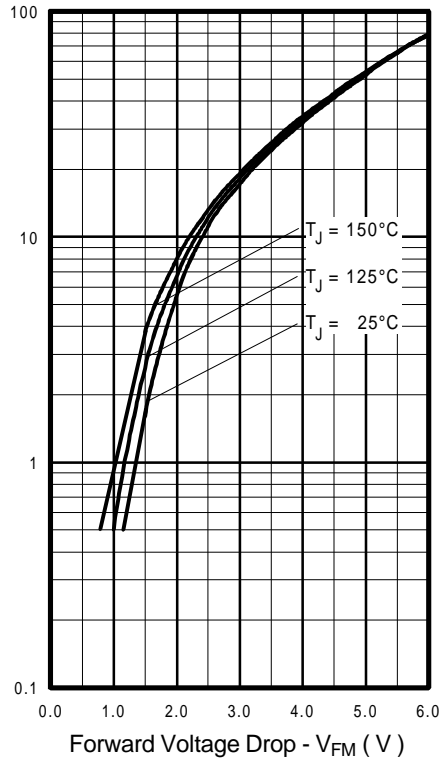

Fig. 13 - Maximum Forward Voltage Drop vs. Instantaneous Forward Current

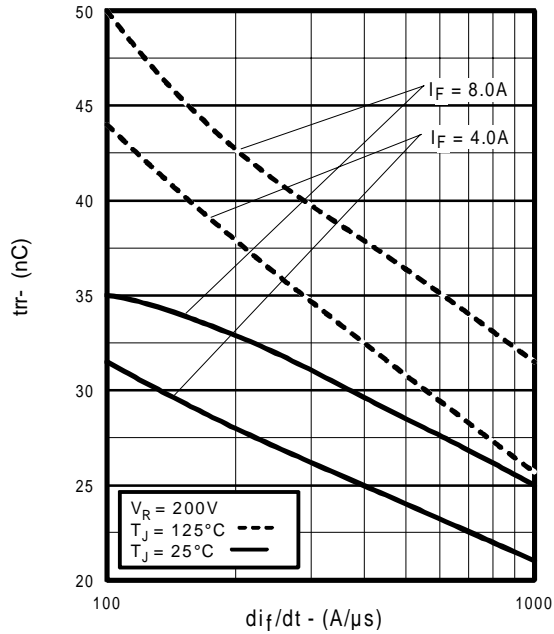

Fig. 14 - Typical Reverse Recovery vs. di_f/dt

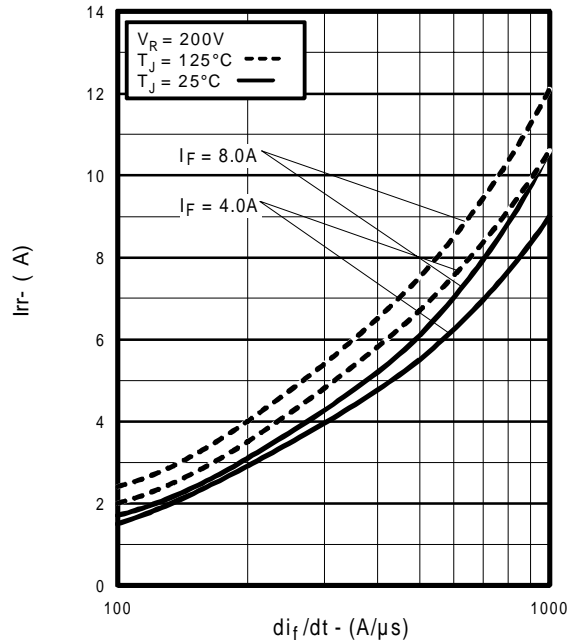

Fig. 15 - Typical Recovery Current vs. di_f/dt

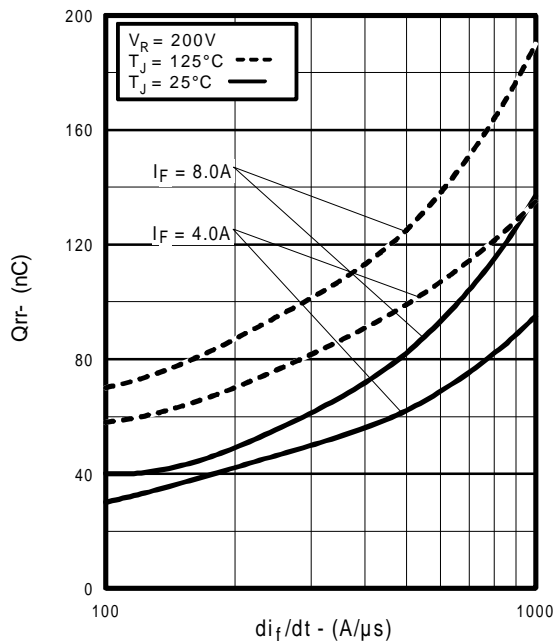

Fig. 16 - Typical Stored Charge vs. di_f/dt

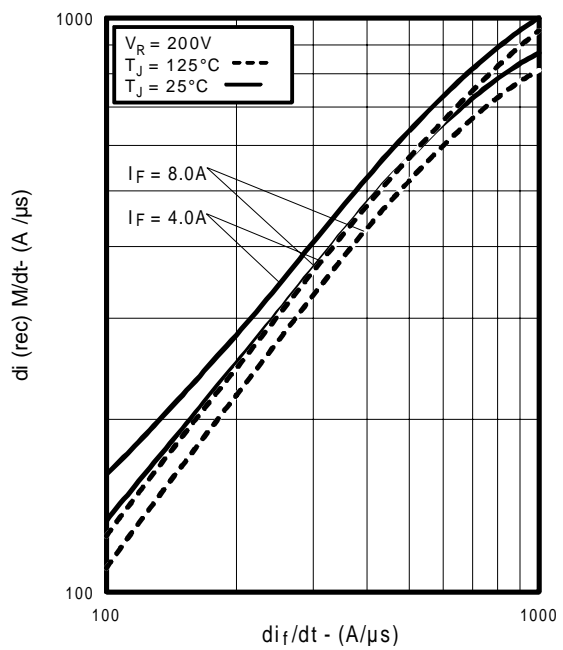

Fig. 17 - Typical $di_{(rec)M}/dt$ vs. di_f/dt

IRG4RC10UD

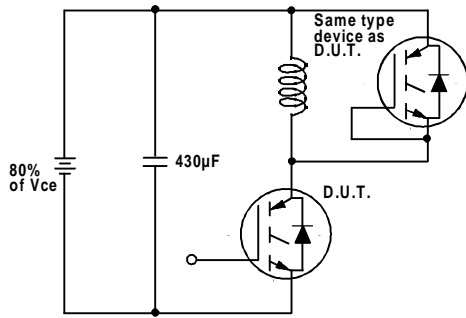

Fig. 18a - Test Circuit for Measurement of I_{LM} , E_{on} , $E_{off}(\text{diode})$, t_{rr} , Q_{rr} , I_{rr} , $t_{d(on)}$, t_r , $t_{d(off)}$, t_f

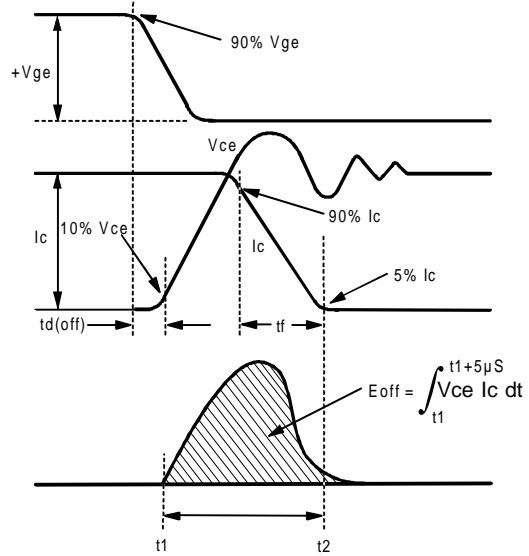

Fig. 18b - Test Waveforms for Circuit of Fig. 18a, Defining E_{off} , $t_{d(off)}$, t_f

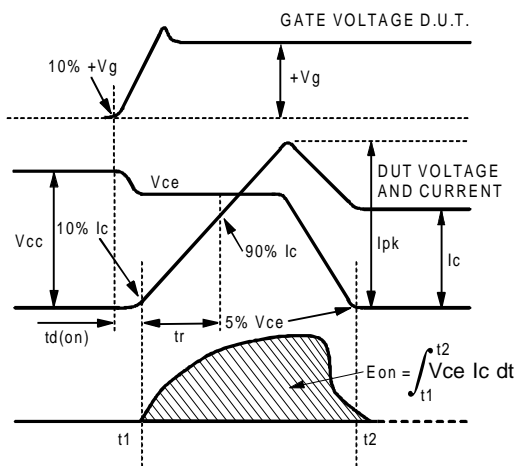

Fig. 18c - Test Waveforms for Circuit of Fig. 18a, Defining E_{on} , $t_{d(on)}$, t_r

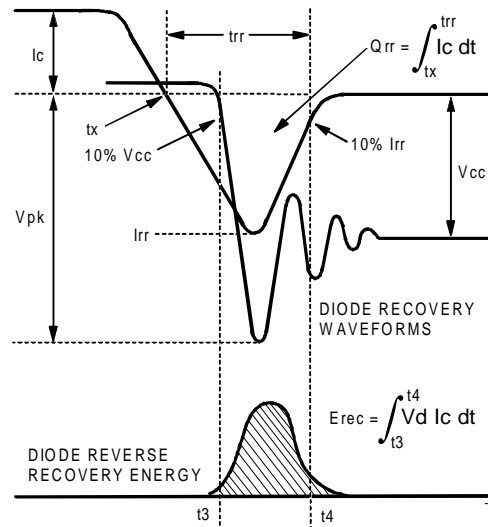

Fig. 18d - Test Waveforms for Circuit of Fig. 18a, Defining E_{rec} , t_{rr} , Q_{rr} , I_{rr}

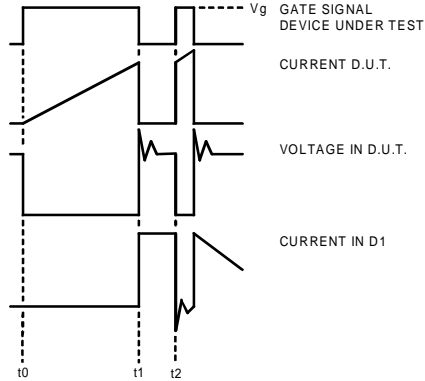

Figure 18e. Macro Waveforms for Figure 18a's Test Circuit

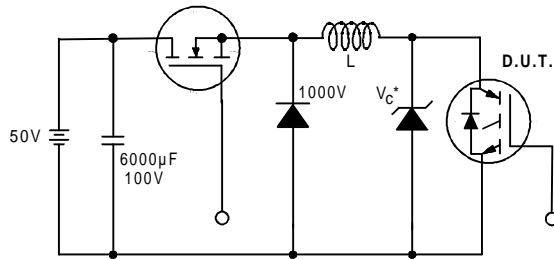

Figure 19. Clamped Inductive Load Test Circuit

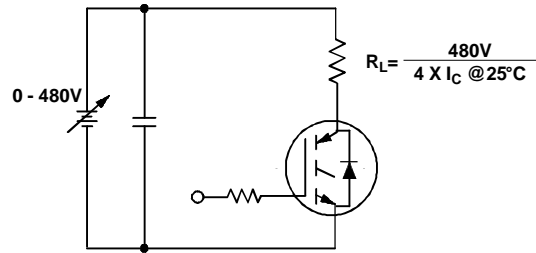
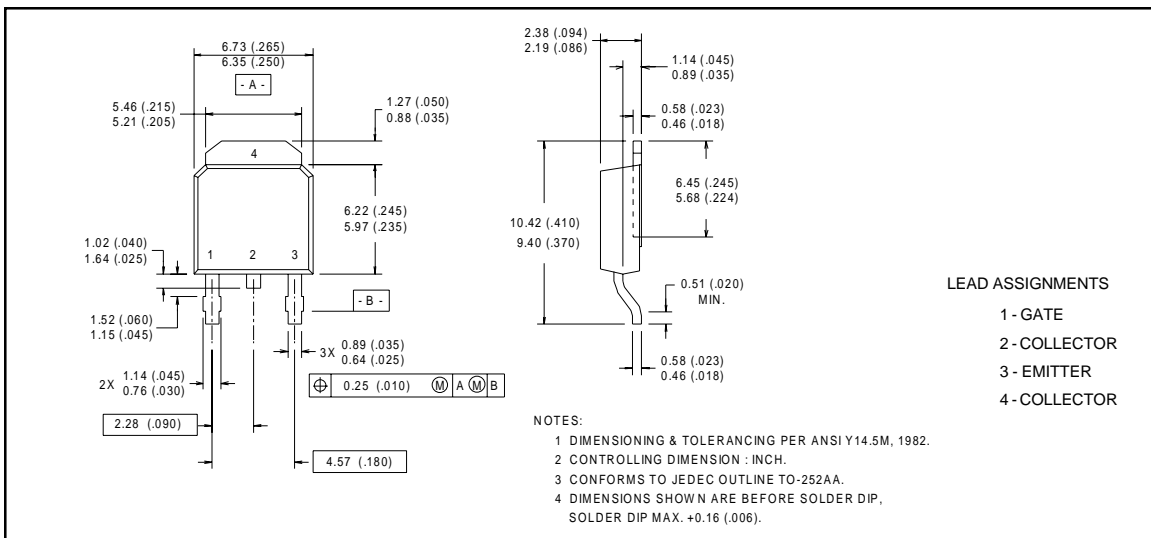

Figure 20. Pulsed Collector Current Test Circuit

Package Outline

TO-252AA Outline

Dimensions are shown in millimeters (inches)



IRG4RC10UD

Notes:

- ① Repetitive rating: $V_{GE}=20V$; pulse width limited by maximum junction temperature (figure 20)
- ② $V_{CC}=80\%(V_{CES})$, $V_{GE}=20V$, $L=10\mu H$, $R_G = 100\Omega$ (figure 19)
- ③ Pulse width $\leq 80\mu s$; duty factor $\leq 0.1\%$.
- ④ Pulse width $5.0\mu s$, single shot.

Tape & Reel Information

TO-252AA

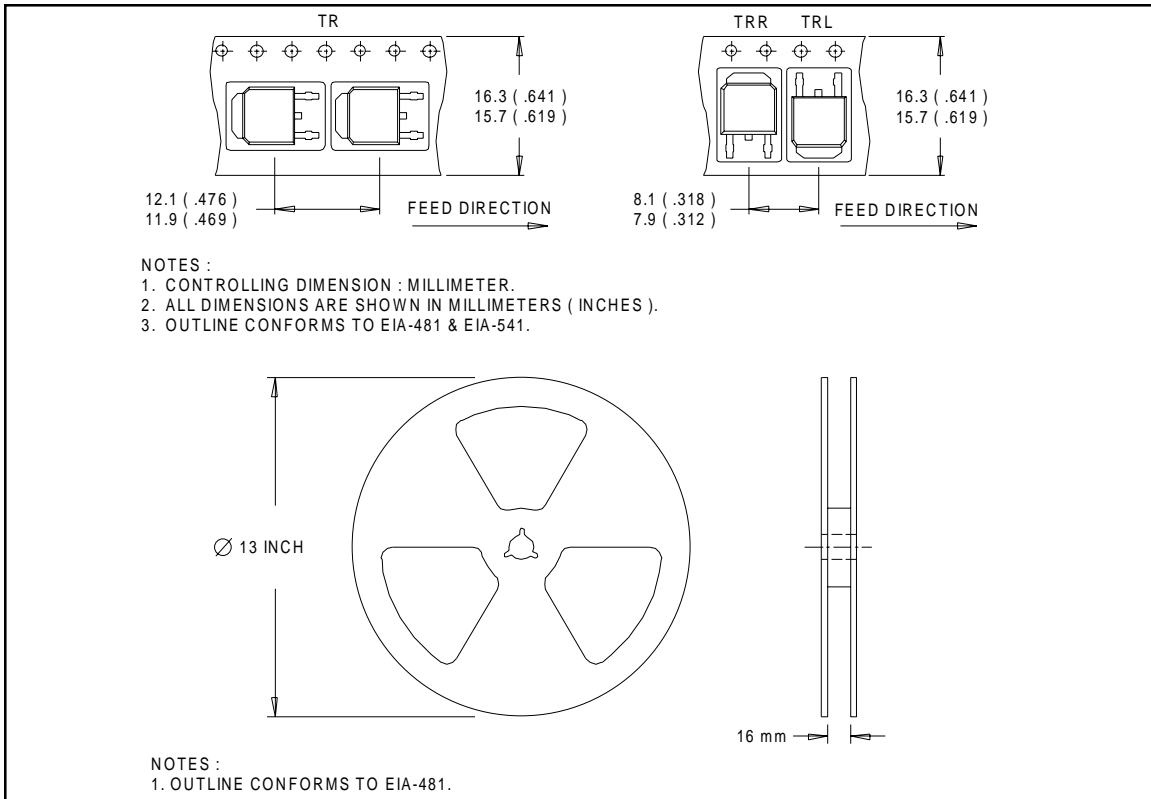

Note: For the most current drawings please refer to the IR website at:
<http://www.irf.com/package/>